

CD Clock Radio Operating instructions

Model No. **RC-CD350**

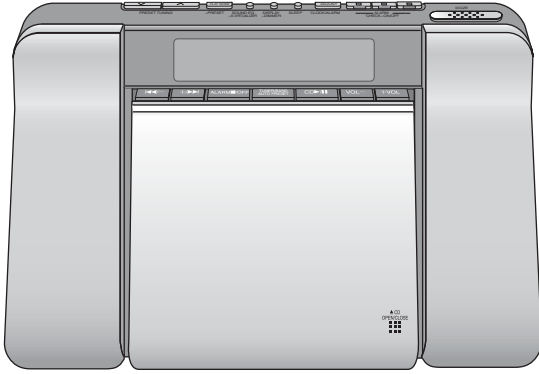

Panasonic Consumer Electronics Company
Division of Matsushita Electric Corporation of America
 One Panasonic Way, Secaucus, New Jersey 07094
<http://www.panasonic.com>
Panasonic Sales Company
Division of Matsushita Electric of Puerto Rico, Inc. ("PSC")
 Ave. 65 de Infantería, Km. 9.5 San Gabriel Industrial Park, Carolina, Puerto Rico 00985

Dear customer

Thank you for purchasing this product.
 Before connecting, operating or adjusting this product, please read these instructions completely. Please keep this manual for future reference.

Illustrations show the model for the United States.

Supplied accessories

1 loop antenna: RSA0031

Use the numbers indicated when asking for replacement parts.
 (Only for U.S.A.)

To order accessories contact 1-800-332-5368 or the website (<http://www.pasc.panasonic.com>).

Panasonic Canada Inc.

5770 Ambler Drive, Mississauga, Ontario L4W 2T3
www.panasonic.ca

© 2003 Matsushita Electric Industrial Co., Ltd.
 Printed in China



RQT7605-P
 H1203ZZ0

Troubleshooting guide

Before requesting service, make the below checks. If you are in doubt about some of the check points, or if the remedies indicated in the chart do not solve the problem, see "Product information" at right for assistance.

The clock shows "--:--".	<ul style="list-style-type: none"> Set the clock.
There is a lot of noise.	<ul style="list-style-type: none"> Keep away from mobile phones, televisions, and other tuners. Extend and change the direction of the antenna.
The alarm doesn't sound at the set time.	<ul style="list-style-type: none"> Ensure the alarm's indicator is on ("ALARM 1", "ALARM 2", or "ALARM 3").
The memory has been cleared.	<ul style="list-style-type: none"> Reset the items into the memory. Insert a battery to preserve the memory contents.
"no DISC" appears.	<ul style="list-style-type: none"> You haven't inserted a CD.
Play doesn't start or display is incorrect.	<ul style="list-style-type: none"> Clean the CD. Clean the lens with a blower (SZZP1038C recommended). If the lens gets marked with fingerprints, gently wipe them off with a cotton swab. Wait an hour for condensation to dry, then try again. Make sure the label is facing out. Replace the CD if it is scratched, warped, or irregularly shaped.
The CD or radio display disappears.	<ul style="list-style-type: none"> These displays disappear after a few seconds. To show them again, press [DISPLAY, -DIMMER].

Product service

- Damage requiring service** — The unit should be serviced by qualified service personnel if:
 - The AC power supply cord or the plug has been damaged; or
 - Objects or liquids have gotten into the unit; or
 - The unit has been exposed to rain; or
 - The unit does not operate normally or exhibits a marked change in performance; or
 - The unit has been dropped or the cabinet damaged.
- Servicing** — Do not attempt to service the unit beyond that described in these operating instructions. Refer all other servicing to authorized servicing personnel.
- Replacement parts** — When parts need replacing ensure the servicer uses parts specified by the manufacturer or parts that have the same characteristics as the original parts. Unauthorized substitutes may result in fire, electric shock, or other hazards.
- Safety check** — After repairs or service, ask the servicer to perform safety checks to confirm that the unit is in proper working condition.

Product information

For product information or assistance with product operation:
 In the U.S.A., contact the Panasonic Customer Call Center at 1-800-211-7262, or the website <http://www.panasonic.com/contactinfo>, or the website <http://www.panasonic.com/support>.
 In Canada, contact the Panasonic Canada Inc. Customer Care Centre at 905-624-5505, or visit the website (www.panasonic.ca), or an authorized Servicentre close to you.

The model number and serial number of this product can be found on either the back or the bottom of the unit.
 Please note them in the space provided below and keep for future reference.

MODEL NUMBER RC-CD350

SERIAL NUMBER _____

User memo:

DATE OF PURCHASE _____

DEALER NAME _____

DEALER ADDRESS _____

TELEPHONE NUMBER _____

IMPORTANT SAFETY INSTRUCTIONS

Read these operating instructions carefully before using the unit. Follow the safety instructions on the unit and the applicable safety instructions listed below. Keep these operating instructions handy for future reference.

- 1) Read these instructions.
- 2) Keep these instructions.
- 3) Heed all warnings.
- 4) Follow all instructions.
- 5) Do not use this apparatus near water.
- 6) Clean only with dry cloth.
- 7) Do not block any ventilation openings. Install in accordance with the manufacturer's instructions.
- 8) Do not install near any heat sources such as radiators, heat registers, stoves, or other apparatus (including amplifiers) that produce heat.
- 9) Do not defeat the safety purpose of the polarized or grounding-type plug. A polarized plug has two blades with one wider than the other. A grounding-type plug has two blades and a third grounding prong. The wide blade or the third prong are provided for your safety. If the provided plug does not fit into your outlet, consult an electrician for replacement of the obsolete outlet.

- 10) Protect the power cord from being walked on or pinched particularly at plugs, convenience receptacles, and the point where they exit from the apparatus.
- 11) Only use attachments/accessories specified by the manufacturer.
- 12) Use only with the cart, stand, tripod, bracket, or table specified by the manufacturer, or sold with the apparatus. When a cart is used, use caution when moving the cart/apparatus combination to avoid injury from tip-over.
- 13) Unplug this apparatus during lightning storms or when unused for long periods of time.
- 14) Refer all servicing to qualified service personnel. Servicing is required when the apparatus has been damaged in any way, such as power-supply cord or plug is damaged, liquid has been spilled or objects have fallen into the apparatus, the apparatus has been exposed to rain or moisture, does not operate normally, or has been dropped.



CAUTION!

THIS PRODUCT UTILIZES A LASER. USE OF CONTROLS OR ADJUSTMENTS OR PERFORMANCE OF PROCEDURES OTHER THAN THOSE SPECIFIED HEREIN MAY RESULT IN HAZARDOUS RADIATION EXPOSURE. DO NOT OPEN COVERS AND DO NOT REPAIR YOURSELF. REFER SERVICING TO QUALIFIED PERSONNEL.

CAUTION!

DO NOT INSTALL OR PLACE THIS UNIT IN A BOOKCASE, BUILT-IN CABINET OR IN ANOTHER CONFINED SPACE. ENSURE THE UNIT IS WELL VENTILATED. TO PREVENT RISK OF ELECTRIC SHOCK OR FIRE HAZARD DUE TO OVERHEATING, ENSURE THAT CURTAINS AND ANY OTHER MATERIALS DO NOT OBSTRUCT THE VENTILATION VENTS.

WARNING:

TO REDUCE THE RISK OF FIRE, ELECTRIC SHOCK OR PRODUCT DAMAGE, DO NOT EXPOSE THIS APPARATUS TO RAIN, MOISTURE, DRIPPING OR SPLASHING AND THAT NO OBJECTS FILLED WITH LIQUIDS, SUCH AS VASES, SHALL BE PLACED ON THE APPARATUS.

THE FOLLOWING APPLIES ONLY IN THE U.S.A.

CAUTION:

This equipment has been tested and found to comply with the limits for a Class B digital device, pursuant to Part 15 of the FCC Rules. These limits are designed to provide reasonable protection against harmful interference in a residential installation. This equipment generates, uses and can radiate radio frequency energy and, if not installed and used in accordance with the instructions, may cause harmful interference to radio communications. However, there is no guarantee that interference will not occur in a particular installation. If this equipment does cause harmful interference to radio or television reception, which can be determined by turning the equipment off and on, the user is encouraged to try to correct the interference by one or more of the following measures:

- Reorient or relocate the receiving antenna.
- Increase the separation between the equipment and receiver.
- Connect the equipment into an outlet on a circuit different from that to which the receiver is connected.
- Consult the dealer or an experienced radio/TV technician for help.

Any unauthorized changes or modifications to this equipment would void the user's authority to operate this device.

This device complies with Part 15 of the FCC Rules. Operation is subject to the following two conditions: (1) This device may not cause harmful interference, and (2) this device must accept any interference received, including interference that may cause undesired operation.



CAUTION

**RISK OF ELECTRIC SHOCK
DO NOT OPEN**



CAUTION: TO REDUCE THE RISK OF ELECTRIC SHOCK, DO NOT REMOVE SCREWS. NO USER-SERVICEABLE PARTS INSIDE. REFER SERVICING TO QUALIFIED SERVICE PERSONNEL.



The lightning flash with arrowhead symbol, within an equilateral triangle, is intended to alert the user to the presence of uninsulated "dangerous voltage" within the product's enclosure that may be of sufficient magnitude to constitute a risk of electric shock to persons.



The exclamation point within an equilateral triangle is intended to alert the user to the presence of important operating and maintenance (servicing) instructions in the literature accompanying the appliance.

Only for Canada

CAUTION	INVISIBLE LASER RADIATION WHEN OPEN AND INTERLOCKS DEFEATED. AVOID EXPOSURE TO BEAM. (IEC 60825-1 Class 3B)
ATTENTION	RAYONNEMENT LASER INVISIBLE DANGEREUX EN CAS D'OUVERTURE ET LORSQUE LA SECURITE EST NEUTRALISEE. EXPOSITION DANGEREUSE AU FAISCEAU.
ADVARSEL	USYNLIG LASERSTRÅLING VED ÅBNING. NÅR SIKKERHEDSÅBRYDERE ER LØSE AF FUNKTION, UNDGÅ UDSETTELSE FOR STRÅLING.
VARO!	AVIATTAESSA JA SUOJALUKITUS OHITETTÄSSÄ OLET ALTUUNA NÄKYMÄTÖNÄ LASERSÄTEKILLE, ALA KATSO SÄTEESEEN.
VARNING	OSYNLIG LASERSTRÅLING NÄR DENNA DEL ÄR ÖPPNAD OCH SPÄRREN ÄR URKOPPLAD. BETRÄKTA EJ STRÅLEN.
VORSICHT	UNSIICHTBARE LASERSTRALUNG, WENN ABDECKUNG GEÖFFNET UND SICHERHEITSVERREGELUNG ÜBERBRÜCKT, NICHT DEM STRAHL AUSSETZEN.
ADVARSEL	USYNLIG LASERSTRÅLING NÄR DENSEL ÅPNES OG SIKKERHEDSLÅS BRYTES, UNDGÅ EKSPONERING FOR STRÅLEN. (ICLXLS00053)

(Inside of product)

Cautions

Batteries

- Do not heat, disassemble, or allow contact with flame or water.
- Do not peel off the covering and do not use if the covering has been peeled off.

Battery mishandling can cause electrolyte leakage which can damage items the fluid contacts and may cause a fire.

If electrolyte leaks from batteries, consult your dealer.

Wash thoroughly with water if electrolyte comes in contact with any part of your body.

CDs

- Do not use irregularly shaped CDs.
- Do not use non-specification discs.
- Do not use CDs printed with label printers available on the market.
- Do not use CDs with labels and stickers that are coming off or with adhesive exuding from under labels and stickers.

Note on CD-R/RW

This unit can play CD-R and CD-RW recorded with CD-DA. Use an audio recording disc and finalize* it when you finish recording. The unit may not be able to play some discs due to the condition of the recording.

*A process that enables CD-R/CD-RW players to play audio CD-R and CD-RW.

Specifications

Frequency range

FM: 87.9 to 107.9 MHz (200 kHz steps)
87.5 to 108.0 MHz (100 kHz steps)

AM: 520 to 1710 kHz

WB: 162.40 to 162.55 MHz

Sampling frequency 44.1 kHz

Decoding 16 bit linear

Beam source Semiconductor laser (wavelength 780 nm)

Number of channels 2 channel, stereo

Wow and flutter Less than possible measurement data

DA converter 1 bit DAC

Speakers 4.5 cm (1 3/4") 6 Ω x 2

Power requirement AC 120 V, 60 Hz

Power consumption: 14 W

Memory back-up 9 V (One 6F22/6LR61, 006P battery)

Dimensions (W x H x D) 266x149x137 mm (10 15/32"x 5 7/8"x 5 3/8")

Mass 1.42 kg (3 lb 2 oz) without battery

Power consumption in standby mode: 2.3 W

Note

Specifications are subject to change without notice.

Mass and dimensions are approximate.

Maintenance

To clean this unit, wipe with a soft, dry cloth.

- Never use alcohol, paint thinner or benzine to clean this unit.
- Before using chemically treated cloth, read the instructions that came with the cloth carefully.

Warranty (U.S.A.)

Panasonic Consumer Electronics Company,
Division of Matsushita Electric Corporation of America
One Panasonic Way Secaucus, New Jersey 07094

Panasonic Sales Company, Division of Matsushita Electric
of Puerto Rico, Inc.,
Ave. 65 de Infantería, Km. 9.5
San Gabriel Industrial Park, Carolina, Puerto Rico 00985

Panasonic Audio Products Limited Warranty

Limited Warranty Coverage

If your product listed below does not work properly because of a defect in materials or workmanship, Panasonic Consumer Electronics Company or Panasonic Sales Company (collectively referred to as "the warrantor") will, for the length of the period indicated on the chart below, which starts with the date of original purchase ("warranty period"), at its option either (a) repair your product with new or refurbished parts, or (b) replace it with a new or a refurbished product. The decision to repair or replace will be made by the warrantor.

Product or Part Name	Parts	Labor
Radio, Clock Radio, Radio with Tape Player or Recorder, Portable CD Player, Headphone Stereo, Tape Recorder, Speaker	One (1) Year	One (1) Year
Rechargeable batteries (in exchange for defective item)	Ten (10) Days	Not Applicable
SD Memory Card (in exchange for defective item)	Ninety (90) Days	Not Applicable

During the "Labor" warranty period there will be no charge for labor. During the "Parts" warranty period, there will be no charge for parts. You must mail-in your product during the warranty period. This Limited Warranty excludes both parts and labor for batteries, antennas, and cosmetic parts (cabinet). This warranty only applies to products purchased and serviced in the United States or Puerto Rico. This warranty is extended only to the original purchaser of a new product which was not sold "as is". A purchase receipt or other proof of the original purchase date is required for warranty service.

To obtain service in the USA please contact:

Panasonic Service Company, Panasonic Plus Department
20421 84th Avenue South
Kent, WA 98032
Tel: 1-800-833-9626 Fax: 1-800-237-9080

For assistance in Puerto Rico call Panasonic Sales Company (787)-750-4300 or fax (787)-768-2910.

When shipping the unit carefully pack and send it prepaid, adequately insured and preferably in the original carton. Include a letter detailing the complaint and provide a day time phone number where you can be reached.

Customer Services Directory

Obtain Product Information and Operating Assistance; locate your nearest Dealer or Servicenter; purchase Parts and Accessories; or make Customer Service and Literature requests by visiting our Web Site at: <http://www.panasonic.com/support>

or, contact us via the web at:

<http://www.panasonic.com/contactinfo>

You may also contact us directly at:

1-800-211-PANA (7262),

Monday-Friday 9 am-9 pm; Saturday-Sunday 10 am-7 pm, EST.

For hearing or speech impaired TTY users, TTY: 1-877-833-8855

Limited Warranty Limits And Exclusions

This warranty ONLY COVERS failures due to defects in materials or workmanship, and DOES NOT COVER normal wear and tear or cosmetic damage. The warranty ALSO DOES NOT COVER damages which occurred in shipment, or failures which are caused by products not supplied by the warrantor, or failures which result from accidents, misuse, abuse, neglect, mishandling, misapplication, alteration, faulty installation, set-up adjustments, misadjustment of consumer controls, improper maintenance, power line surge, lightning damage, modification, introduction of sand, humidity or liquids, commercial use such as hotel, office, restaurant, or other business or rental use of the product, or service by anyone other than a Factory Servicenter or other Authorized Servicer, or damage that is attributable to acts of God.

THERE ARE NO EXPRESS WARRANTIES EXCEPT AS LISTED UNDER "LIMITED WARRANTY COVERAGE".

THE WARRANTOR IS NOT LIABLE FOR INCIDENTAL OR CONSEQUENTIAL DAMAGES RESULTING FROM THE USE OF THIS PRODUCT, OR ARISING OUT OF ANY BREACH OF THIS WARRANTY. (As examples, this excludes damages for lost time, cost of having someone remove or re-install an installed unit if applicable, travel to and from the servicer, loss of or damage to media or images, data or other memory or recorded content. The items listed are not exclusive, but are for illustration only.)

ALL EXPRESS AND IMPLIED WARRANTIES, INCLUDING THE WARRANTY OF MERCHANTABILITY, ARE LIMITED TO THE PERIOD OF THE LIMITED WARRANTY.

Some states do not allow the exclusion or limitation of incidental or consequential damages, or limitations on how long an implied warranty lasts, so the exclusions may not apply to you.

This warranty gives you specific legal rights and you may also have other rights which vary from state to state. If a problem with this product develops during or after the warranty period, you may contact your dealer or Servicenter. If the problem is not handled to your satisfaction, then write to the warrantor's Consumer Affairs Department at the addresses listed for the warrantor.

PARTS AND SERVICE, WHICH ARE NOT COVERED BY THIS LIMITED WARRANTY, ARE YOUR RESPONSIBILITY.

Accessory Purchases

Purchase Parts, Accessories and Instruction Books online for all Panasonic Products by visiting our Web Site at: <http://www.pasc.panasonic.com>

or, send your request by E-mail to: npcparts@panasonic.com

You may also contact us directly at:

1-800-332-5368 (Phone) 1-800-237-9080 (Fax Only) (Monday - Friday 9 am to 8 pm, EST.)

Panasonic Services Company

20421 84th Avenue South, Kent, WA 98032

(We Accept Visa, MasterCard, Discover Card, American Express, and Personal Checks)

For hearing or speech impaired TTY users, TTY: 1-866-605-1277

Service in Puerto Rico

Matsushita Electric of Puerto Rico, Inc. Panasonic Sales Company Factory Servicenter:
Ave. 65 de Infantería, Km. 9.5, San Gabriel Industrial Park, Carolina, Puerto Rico 00985
Phone (787)750-4300, Fax (787)768-2910

Connect the antenna

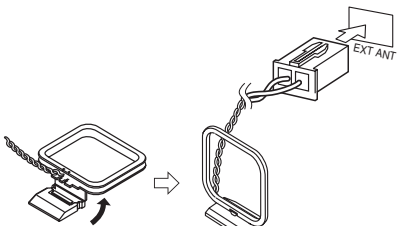

- Stand the antenna up so it clicks into place.
- When disconnecting, pull firmly.

Improving reception

- Extend and change the direction of the antenna.

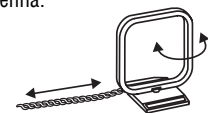

Connect the AC power supply cord

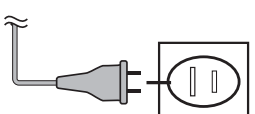

Household AC outlet
(AC 120 V/60 Hz).

Insert a battery (not included) for memory backup (bottom of unit)

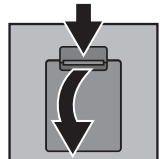
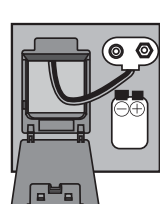
- Press down on the catch and pull down.
 
- Pull out the connector and attach the battery.
 

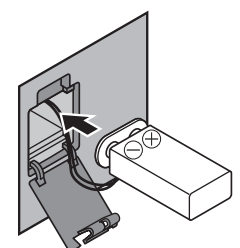
6F22/6LR61,
006P battery
(not included)
- Insert the battery as shown.
 

This battery saves the clock, alarm, and radio-preset settings if power is interrupted. It lasts about a year (one month without AC power).

Note



These speakers do not have magnetic shielding. Do not place them near televisions, personal computers or other devices easily influenced by magnetism.

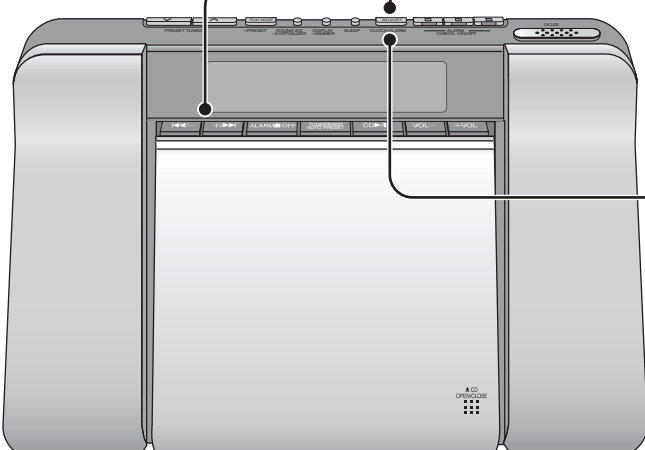

Setting the clock

This is a 12-hour clock. This example shows how to set the clock for 3:30 P.M. Reset the clock regularly to maintain accuracy. (Monthly accuracy +/- 30 seconds.)



- Press to select the time setting
 

Summer time setting (☀) → Time setting
(Original display) ←
- Within 10 seconds, press to set the time
 

Press and hold to change the time faster.
- Press to start the clock and finish
 

The display returns to its original state after a confirmation tone is heard.

Summer time

Do the following to advance the clock by an hour during the summer months.

- Press [ADJUST, CLOCK/ALARM] to select the summer time setting (☀).
- Press [←/→] or [←/→] to select "on".
- Press [ADJUST, CLOCK/ALARM] to finish (a tone sounds).
☀ appears and the clock advances by an hour.

Repeat the above, selecting "OFF" in step 2, to turn ☀ off and restore the time.

Manual tuning

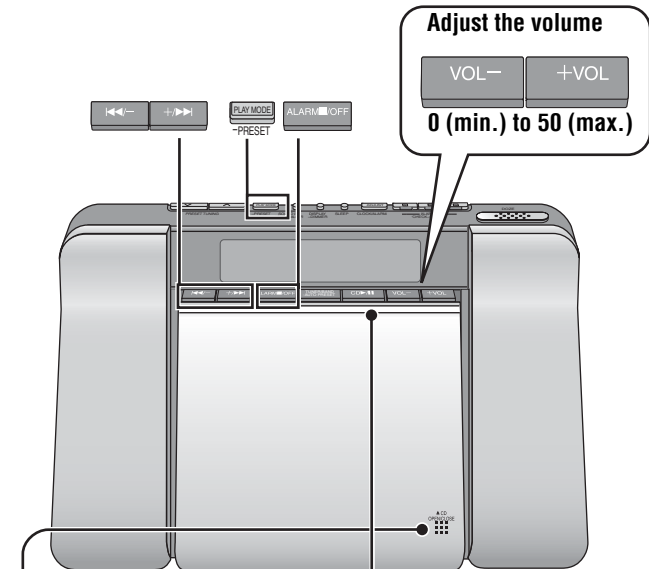

1 Press to open, insert a CD, and close securely



2 Press to play



The unit turns off automatically after finishing play of the last track.

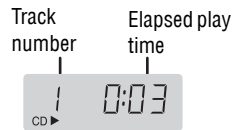

Insert label out so it clicks into place

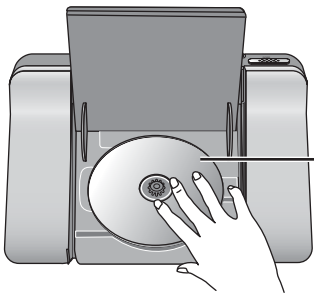

To prevent damage to the CD, stop the disc before opening the CD lid.

Pause	Press Press again to restart play
Stop and off	Press Note When the CD is stopped the unit also turns off automatically. You cannot use skip, search, or the play mode.
Skip/Search	Press to skip, press and hold to search Backward Forward
Repeat/Random	Press to select the mode 1-: Repeat one track : Repeat all tracks RND: Play all tracks randomly No display: Play modes off

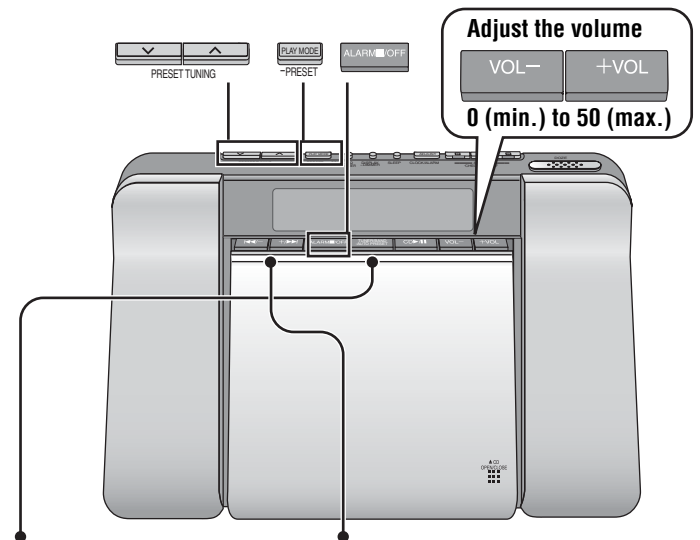

1 Select the band



2 Tune to a station

In step 2, press and hold to start automatic tuning. Tuning stops when a station is found.

Off	Press
FM mode	Press Switch to MONO if there is a lot of noise in FM. Sound will not be stereo but noise should reduce. Press again to cancel.
Weather Band	<ul style="list-style-type: none"> Weather Radio broadcasts warnings, watches, forecasts and other information 24 hours a day on 7 VHF band frequencies (162.40 MHz to 162.55 MHz) in the U.S. and Canada, with each frequency serving specific areas. Choose the channel for your area. For further information: In the U.S. visit http://www.nws.noaa.gov/nwr/ In Canada visit http://www.msc-smc.ec.gc.ca/cd/factsheets/wxradio/index_e.cfm This unit does not have an associated alarm function.
Changing the FM frequency step	In the FM band, press and hold [CD▶] so the frequency starts flashing, then continue to hold down until the step changes from 200 kHz to 100 kHz. Repeat to change back.

Preset tuning

Preset up to 20 FM and 12 AM stations. Use Auto Preset to preset all the stations the unit can receive, or Manual Preset to preset only those stations you want. The seven WEATHER frequencies have been preset for you.

Auto Preset

Do the following once each for FM and AM.

Press and hold



The frequency returns to the lowest in the band, then it scrolls and "AUTO" flashes. The first station to be preset plays when finished.

Manual Preset

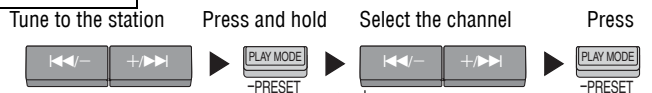

Selecting channels

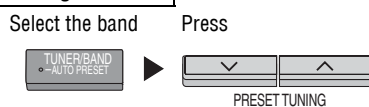

Using the alarms

Set the unit to come on and play a CD or the radio with ALARM 1, or to sound a buzzer with ALARM 2 and ALARM 3.

Preparation: Set the time.

For ALARM 1, play the CD track or radio station and set the unit to the volume you want to wake up to.

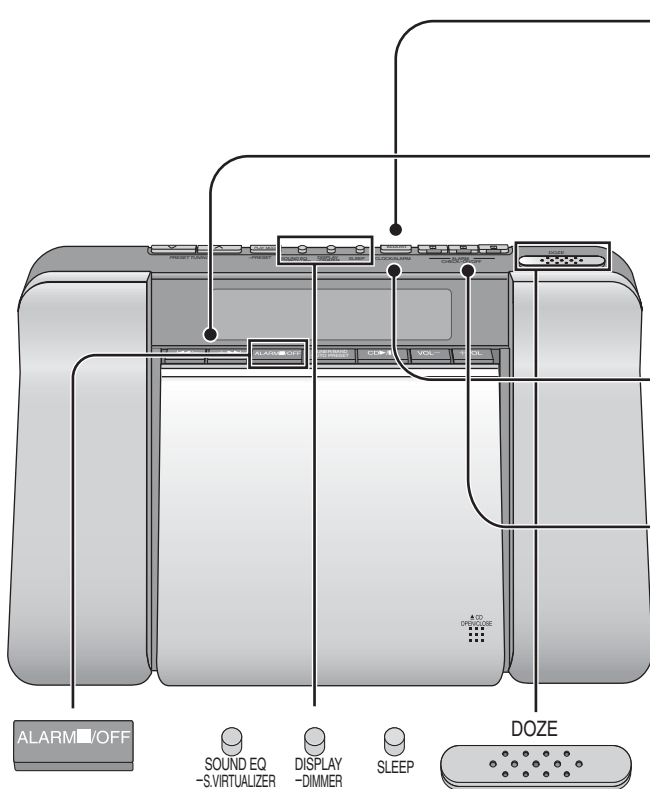

1 Press to select one of the alarm types you want to set (ALARM 1, 2, 3)



Summer time setting (☀) → Time setting → ALARM 1
(Original display) ← ALARM 3 ← ALARM 2

2 Within 10 seconds, press to set the alarm time



Press and hold to change the time faster.

3 Press to confirm

The display returns to its original state after a confirmation tone is heard.



4 Press and hold to turn the alarm on (the [DOZE] button lights)

When more than 2 alarm settings are turned on, only the alarm time that will occur first is displayed.

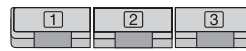

ALARM
-CHECK-ON/OFF

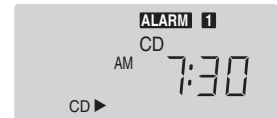

The alarm sounds at the set time and stops automatically after an hour.

ALARM 1 plays the CD track or radio station at the volume set (a buzzer sounds if you take out the CD).

ALARM 2 and 3 sound buzzers (you cannot change the volume of the buzzer).

You can still play a CD or the radio after setting an alarm.

Checking the settings	<p>Press</p>
To turn the alarm off	<p>Press and hold</p> <p>The settings stay the same. Press and hold again to turn on again (while playing the CD or radio for ALARM 1).</p>

Doze	<p>Press</p> <p>The alarm sounds again 6 minutes later.</p>
To shut off the alarm	<p>Press</p> <p>Settings stay the same and the alarm sounds again the next day.</p>

Other features

Sound quality

Sound Equalizer

Press



Bass: Emphasizes the bass



Clear: Clarifies the treble



Soft: For background music



Vocal: Adds gloss to vocals



Off

EQ appears while Sound EQ is on.

Sound Virtualizer

This stabilizes the midrange, such as vocals, and gives sound natural width and depth. Use it when listening to stereo sources. (Actual effect depends on the source.)

Press and hold



Press and hold again to cancel.

Sleep timer

Set the unit to switch off after a certain number of minutes.

Press



Each time you press the button:

30 → 60 → 90 → 120
OFF ←

To check the remaining time, press once.

Display

The CD and radio displays disappear after a few seconds. To show them again:

Press



Dimmer

Press and hold



6

The display switches between bright and dim each time you do this.